

PartnerMic user guide



| Easy Line™ |
Accessories

A Sonova brand

Welcome

Congratulations on choosing the PartnerMic, a quality product developed by Sonova, one of the world's leading companies in the field of hearing technology.

Please read this user guide carefully to discover how to benefit from the features of your PartnerMic.

If you have any questions, please consult your hearing care professional or go to www.sonova.com



CE mark applied: 2019

Contents

Welcome	2
Getting to know your PartnerMic	5
Device description	6
Accessories	7
Getting started.....	8
Charging the device	8
Switching on/off.....	9
Pairing the PartnerMic to the hearing aids	10
Streaming stability	13
Daily use of the PartnerMic	14
How to wear.....	14
Positioning of the PartnerMic.....	15
Understanding the indicator light (LED)	16
Low battery warning.....	16
Adjusting the volume.....	17
Troubleshooting.....	18
Service and warranty	20
Compliance information	22
Information and description of symbols	26
Important safety information	28

PartnerMic at a glance

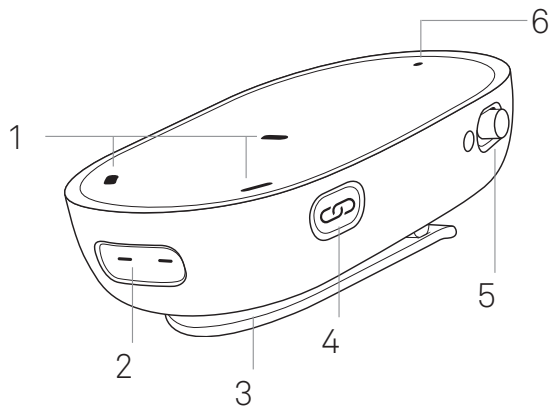

- 1 Microphone openings
- 2 Charging input
- 3 Clip
- 4 Pairing button
- 5 Power switch On/Off
- 6 Indicator light

Accessories

(content may vary depending on country)

- USB-C cable
- Lanyard
- Protective bag
- Adapter for 12 V car charger (optional)

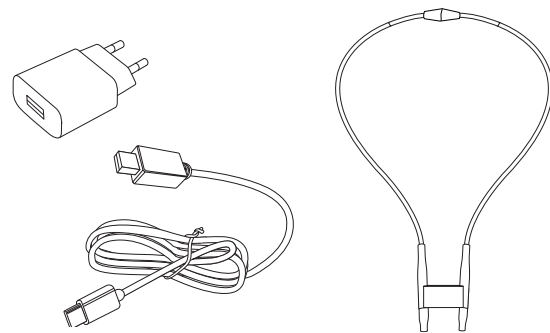

Getting started

Charging the device

PartnerMic has a built-in, non-removable, rechargeable battery.

ⓘ When charging the PartnerMic for the first time, let it charge for at least 2 hours, even if the indicator light is not lit or turns green.

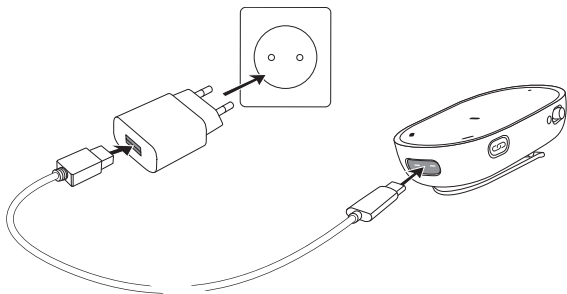

- Plug the power supply into a power socket
- Plug the USB plug into the PartnerMic charging input
- The typical charging time is 2 hours
- Charging is complete when the indicator light turns solid green

ⓘ PartnerMic will be turned off while charging.

Switching on/off

Slide the power switch to turn the PartnerMic on or off. Switch it off when not in use.

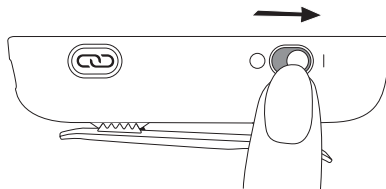

Pairing the PartnerMic to the hearing aids

PartnerMic needs to be paired to your hearing aids before use. If the PartnerMic has not been paired to a hearing aid before, it will automatically enter pairing mode at start up and blink blue.

① If you have received the PartnerMic and the hearing aids in a set, they may already be paired.

- Make sure your hearing aid(s) are turned on
- Start the PartnerMic and hold it within 10 cm (4 inches) of the hearing aid
- Pairing is complete when the indicator light turns green. You will also hear a confirmation beep in your hearing aid(s).

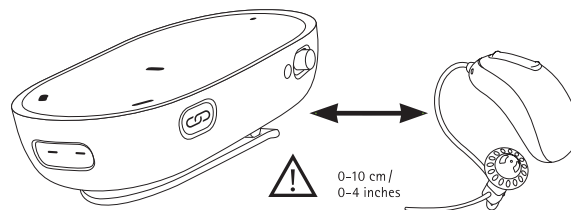

① You only have to pair the hearing aids once. They will remain paired after being turned off and on again.

To redo the pairing procedure you can manually activate the pairing mode by pressing the pairing button.

- Place the PartnerMic within 10 cm (4 inches) range from the hearing aid
- Press the pairing button
- Pairing is complete when the indicator light turns green

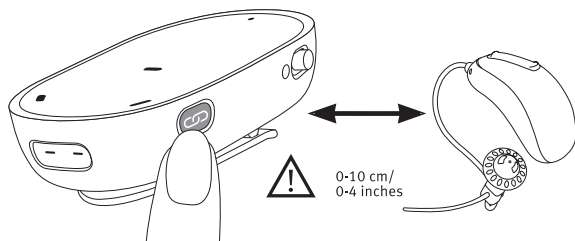

ⓘ Once successfully paired, any previously paired hearing aid will be unpaired.

Streaming stability

PartnerMic has a streaming range of up to 25 meters (80 ft).

The range may be reduced when the signal is obstructed by obstacles such as walls, furniture or the human body.

If the hearing aids are out of range of the PartnerMic the audio reception will be terminated. Once the hearing aids are back into the range of the PartnerMic, the audio reception will automatically resume.

Daily use of the PartnerMic

How to wear

PartnerMic is worn by the speaking partner, attached with the clip or hanging on a lanyard.

With a clip:

- Gently press to open the clip
- Ensure the PartnerMic is clipped securely to clothing

With a lanyard:

- Attach the PartnerMic to the lanyard with the clip
- Put the lanyard around the neck
- Adjust the length by pulling the loose ends



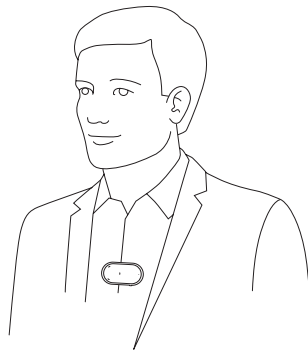

Positioning of the PartnerMic

- For optimal performance, place the PartnerMic 20 cm (8") below the wearer's mouth
- A distance of 50 cm (20") should not be exceeded
- Avoid tilting the PartnerMic beyond 45°
- If the clip cannot be fastened to clothing use the supplied lanyard
- To prevent scraping sounds, do not cover the PartnerMic with clothing during use



Understanding the indicator light (LED)

During operation

Solid green 3 sec		Switching on
Blinking red		Low battery (~30min left)
Blinking blue		Pairing mode
Solid red 5 sec		Pairing failed
Staying solid red		Device error

During charging

Blinking green		Charging
Staying solid green		Charging complete

Low battery warning

When the PartnerMic has approximately 30 minutes of battery time left you will hear two beeps every 10 minutes and the indicator light will blink red.

Adjusting the volume

The volume of the PartnerMic can be adjusted with the multi-function button on your hearing aid or from the Remote Control functions within the app, available for both Android and iOS.

Troubleshooting

Cause	What to do
Issue: I don't hear any sound from the PartnerMic	
PartnerMic is switched off	Make sure the device is turned on and fully operational
PartnerMic is not paired with the hearing aids	Pair the PartnerMic to the hearing aids
The distance between the PartnerMic and the hearing aids is too great	Bring the devices closer to each other
An obstacle is preventing transmission	Depending on the material (e.g. the human body), line of sight may be necessary
Issue: I hear drop-outs during audio transfer	
PartnerMic is too far away from the hearing aid or shielded by an obstacle (e.g. human body)	Do not exceed the maximum distance and adjust the device orientations

Cause	What to do
Issue: The volume during streaming is not comfortable (too low or too high)	
The volume levels are not set correctly	Adjust the volume using the multi-function button on your hearing aid or the Remote Control functions within the app.
Issue: There is too much noise, I cannot understand the speaker	
Your hearing aid microphones are set too high	Reduce the hearing aid volume by a pressing the multi-function button on your hearing aid
PartnerMic is not worn correctly	Place the PartnerMic closer to the mouth of the speaker (20 cm / 8") and make sure it is not tilted beyond 45°. Clothing should not cover the PartnerMic
The settings of your hearing aids are not right	Please ask your hearing care professional to finetune your hearing aids

Service and warranty

Local warranty

Please ask the hearing care professional, where you purchased your devices, about the terms of the local warranty.

International warranty

Sonova offers a one year limited international warranty, valid as of the date of purchase. This limited warranty covers manufacturing and material defects. The warranty is valid only if proof of purchase is shown.

The international warranty does not affect any legal rights that you might have under applicable national legislation governing sale of consumer goods.

Warranty limitation

This warranty does not cover damage from improper handling or care, exposure to chemicals, immersion in water or undue stress. Damage caused by third parties or non-authorized service centers renders the warranty null and void. This warranty does not cover any services performed by a hearing care professional in his/her office.

Serial number: _____

Date of purchase: _____

Authorized hearing care professional (stamp/signature):

Compliance information

Europe:

Declaration of Conformity

Hereby Sonova AG declares that this product is in compliance with the essential requirements of the Radio Equipment Directive 2014/53/EU.

The full text of the Declaration of Conformity can be obtained from the manufacturer or the local representative whose address can be taken from www.phonak.com/us/en/certificates

Operation frequency: 2400 - 2483.5 MHz

Power level: <20 mW conducted power

Australia/New Zealand:



R-NZ

Indicates a device's compliance with applicable Radio Spectrum Management's (RSM) and Australian Communications and Media Authority (ACMA) regulatory arrangements for the legal sale in New Zealand and Australia.

The compliance label R-NZ is for radio products supplied in the New Zealand market under conformity level A1.

Notice 1:

This device complies with Part 15 of the FCC Rules and with Industry Canada's license – exempt RSSs. Operation is subject to the following two conditions:

- 1) this device may not cause harmful interference, and
- 2) this device must accept any interference received, including interference that may cause undesired operation.

Notice 2:

Changes or modifications made to this device not expressly approved by Sonova AG may void the FCC authorization to operate this device.

Notice 3:

This device has been tested and found to comply with the limits for a Class B digital device, pursuant to Part 15 of the FCC Rules and ICES-003 of Industry Canada. These limits are designed to provide reasonable protection against harmful interference in a residential installation. This device generates, uses

and can radiate radio frequency energy and, if not installed and used in accordance with the instructions, may cause harmful interference to radio communications. However, there is no guarantee that interference will not occur in a particular installation. If this device does cause harmful interference to radio or television reception, which can be determined by turning the equipment off and on, the user is encouraged to try to correct the interference by one or more of the following measures:

- Reorient or relocate the receiving antenna
- Increase the separation between the device and receiver
- Connect the device into an outlet on a circuit different from that to which the receiver is connected
- Consult the dealer or an experienced radio/TV technician for help

Notice 4:

Japanese Radio Law Compliance

This device is granted pursuant to the Japanese Radio Law (電波法). This device should not be modified (otherwise the granted designation number will become invalid).

Notice 5:

FCC/Industry Canada RF Radiation Exposure Statement

This equipment complies with FCC/Industry Canada RF radiation exposure limits set forth for an uncontrolled environment.

This transmitter must not be co-located or operating in conjunction with any other antenna or transmitter.

Information and description of symbols



The CE symbol is confirmation by Sonova AG that this product is in compliance with the Radio Equipment Directive 2014/53/EU.



This symbol indicates that it is important for the user to read and take into account the relevant information in this user guide.



Indicates the device manufacturer.



This symbol indicates that it is important for the user to pay attention to the relevant warning notices in this user guide.



Important information for handling and product safety.

Operating conditions

The device is designed such that it functions without problems or restrictions if used as intended, unless otherwise noted in this user guide.



Indicates the Authorized representative in the European Community.



Temperature transport and storage:
-20° to +60° C (-4° to +140° F).
Temperature operation:
0° to +45° C (+32° to +113° F).



Keep dry.



Humidity during transportation and storage:
<90% (non-condensing).
Humidity operation:
<95% (non-condensing).



Atmospheric pressure:
50 kPa to 106 kPa.



This symbol on the product or its packaging means that it should not be disposed of with your other household waste. It is your responsibility to dispose of your waste equipment separately from the municipal waste stream. The correct disposal of your old appliance will help prevent potential negative consequences for the environment and human health.

Important safety information

Please read the information on the following pages before using your device.

Hazard warnings

⚠ This device is not for children below 36 months. It contains small parts that can cause choking, if swallowed by children. Keep out of reach of children, individuals with cognitive impairment, and pets. If swallowed, consult a physician or hospital immediately.

⚠ The device may generate magnetic fields. If any influence of the PartnerMic on the Implantable Device (e.g. pacemakers, defibrillators, etc.) is experienced, stop using the PartnerMic and contact your doctor and /or the manufacturer of the Implantable device for advice.

⚠ Use only hearing aids that have been specially programmed for you by your hearing care professional.

⚠ Dispose of electrical components in accordance with your local regulations.

⚠ Changes or modifications to any of the devices that were not explicitly approved by Sonova AG are not permitted.

⚠ External devices may only be connected if they have been tested in accordance with the relevant standards IEC 60601-1, IEC 60065, IEC 60950-1, IEC 62368-1 or other applicable safety standards. Only use accessories approved by Sonova AG.

⚠ For safety reasons, only use chargers supplied by Sonova AG.

⚠ Do not use the device in explosive areas (mines or industrial areas with danger of explosions, oxygen rich environments or areas where flammable anesthetics are handled) or where electronic equipment is prohibited.

⚠️ Opening the device might damage it. If problems occur which cannot be resolved by following the remedy guidelines in the troubleshooting section of this user guide, consult your hearing care professional.

⚠️ Lanyard shall not be used if there is a risk of getting stuck, e.g. in a machine or other objects.

Product safety information

- ① Protect the device connectors, plugs, power supply from dirt and debris.
- ① Do not use excessive force when connecting your device to its different cables.
- ① Protect the device from excessive dust, moisture (bathing or swimming areas) and heat sources (radiator). Protect the device from excessive shock and vibration.

① Clean the device using a damp cloth. Never use household cleaning products (washing powder, soap, etc.) or alcohol to clean them. Never use a microwave or other heating devices to dry the device.

① X-ray radiation, CT or MRI scans may destroy or adversely affect the correct functioning of the device.

① If the device has been dropped or damaged, if it overheats, has a damaged cord or plug, or has been dropped into liquid, stop using your device and contact an authorized service centre.

Other important information

① High-powered electronic equipment, larger electronic installations and metallic structures may impair and significantly reduce the operating range.



Sonova AG
Laubisrütistrasse 28
CH-8712 Stäfa, Switzerland



And importer for European Union:
Sonova Deutschland GmbH
Max-Eyth-Str. 20
70736 Fellbach-Oeffingen, Germany





Distributor

A/2020-01 029-6387-02 © 2019 Sonova AG. All rights reserved.

sonova

